

Jeep Wrangler

i407-WRA-JK

Restyle Installation Manual

- Model: Wrangler
- Model Year: 2007-2017

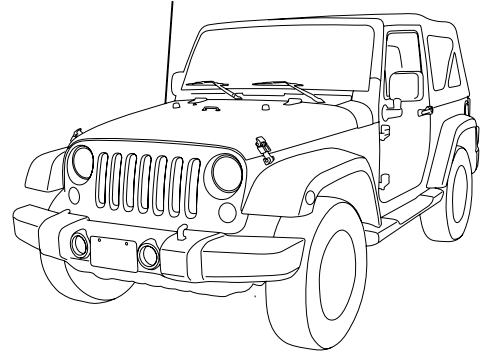

Jeep	Model	Year
	Wrangler	2007-2017

* The specified vehicles have been tested and have met compatibility specs at the time of testing. Compatibility is not guaranteed if the manufacturer has made production changes to the listed vehicles above.

⚠ Warning: Before you begin wiring, remove the ground wire from the negative terminal of the battery. Failing to do so can lead to electric shock, injury or damage to equipment.

Introduction

- Congratulations on purchasing the i407-WRA-JK. This installation manual is designed to take you through the step-by-step installation of the i407-WRA-JK into a 2007 and 2017 Jeep Wrangler. Please familiarize yourself with the owners manual and if you still have additional questions please call 1-800-TECH-101.



Note:

- Design and specifications are subject to change without notice for improvement.





To Ensure Safe Use, Always Follow These Precautions

- The installation of this product requires specialized skills and experience. We recommend that you have the product installed by an Alpine authorized dealer.
- Before you use this product, be sure to carefully read this installation manual and the separate user's manual so that you can use the product correctly. Alpine Electronics bears no responsibility for problems that arise as a result of failure to follow the instructions in the manuals.
- This manual includes a number of symbols that are intended to help you use the product safely, to prevent harm to you and others, and to protect against damage to property. These symbols and their meanings are listed below. Make sure you fully understand these symbols before you begin reading the main text.

Explanations of Injury and Damage That May Result from Incorrect Use

 Warning	Ignoring the content marked by this indication and using the product incorrectly is expected to lead to death or serious injury.
 Caution	Ignoring the content marked by this indication and using the product incorrectly is only expected to lead to injury or property damage.



Types of Precautions

 Forbidden	Indicates actions that are forbidden (must not be performed)
 Forbidden	Indicates that disassembly is forbidden.
 Mandatory	Indicates actions that are mandatory (must be performed)
	Marks content that should receive your full attention.

 **Warning**

Do not disassemble or modify the product. Doing so could lead to an accident, fire, or electric shock.  Forbidden

Store screws and other small objects where children cannot reach them. If one of these small objects is swallowed, consult with a doctor immediately. 

When replacing fuses be sure to use the fuses with the specified current rating. Failing to do so could lead to an accident or fire.   Mandatory Forbidden

Only connect the product to a 12 VDC negative ground car. Failing to do so could lead to an accident or fire.  Mandatory

Before you begin wiring, remove the ground wire from the negative terminal of the battery. Failing to do so could lead to electric shock or injury. 

Do not cut the insulation on a cord and take power from another device. Doing so could lead to fire or electric shock.  Forbidden

Do not install the product in a location where it will obstruct the driver's forward view; interfere with the operation of the steering wheel, gear shift, or the like; or pose a threat to passengers. Doing so could lead to an accident or injury.  Forbidden

When making a hole in the vehicle body, be careful to avoid damaging pipes, the fuel tank, electrical wiring, and the like. This kind of damage could lead to an accident or fire. 

When installing and grounding the product, do not use any of the bolts or nuts of the steering wheel, brakes, fuel tank, or the like. Doing so could make the brakes stop working or could lead to fire.  Forbidden

Do not install the product near the passenger-side airbag. Doing so could interfere with the operation of the airbag and lead to an accident or injury.  Forbidden

Bundle cords so that they don't interfere with driving. Wrapping cords around the steering wheel, gearshift, brake pedal, or the like could lead to an accident or damage equipment. 

 **Caution**

Connect the product properly according to the instructions. Failing to do so could lead to fire or an accident.  Forbidden

Do not sandwich cords between the seat railing or allow them to touch protrusions. Resulting breaks or shorts could lead to electric shock or fire. 



Do not block vents or heat sinks. Doing so could lead to fire or damage equipment. 

Use the accessories according to the instructions, and attach them securely. Failing to do so could lead to an accident or damage equipment.  Forbidden

Do not install the product where it may be exposed to water or in a place with high levels of humidity or dust. Doing so could lead to fire or damage equipment.  Forbidden

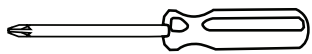
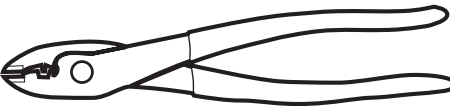
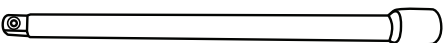
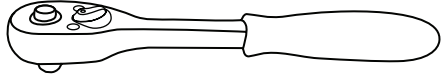
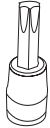
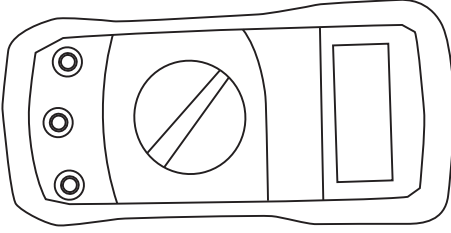
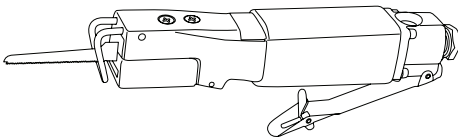
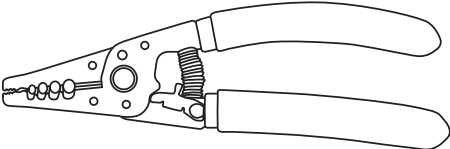
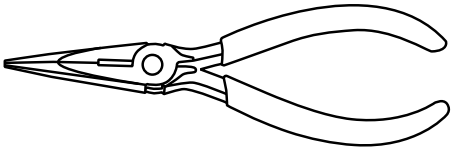

The installation and wiring of this product requires specialized skills and experience. Have the product installed by an Alpine authorized dealer. 

Tools Required

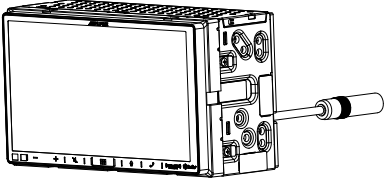

Panel Removing Tool	7mm Sockets	#2 Phillips Screwdriver
		
Wire Cutters	Extension	Ratchet
		
T20 Torx	Digital Multimeter	Air Saw
		
Wire Strippers	Pliers	
		

Accessory List

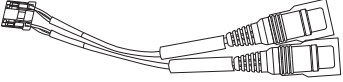
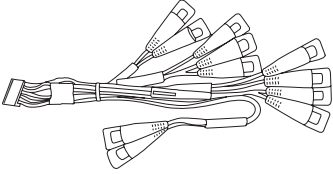
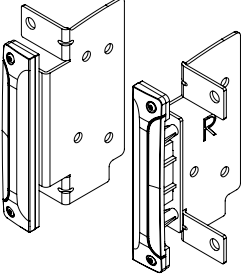
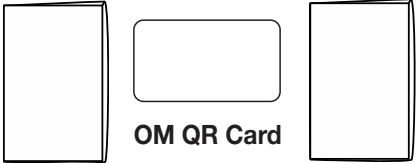
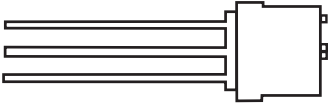
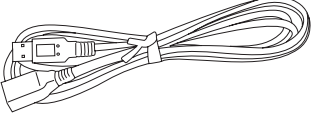
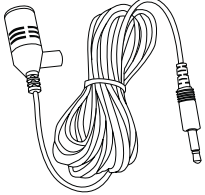
Head Unit Box Parts (i407-WRA)

<p>iLX-407 Head Unit</p> 	<p>Round Head Screws M5#8 (4pcs)</p> 	<p>Video In/Out Harness</p> 
<p>Camera/Preout Harness</p> 	<p>Side Mounting Brackets L&R</p> 	<p>Documents</p>  <p style="text-align: center;"> Alpine Registration Card OM QR Card Installation Manual </p>
<p>Aux Power Pig Tail</p> 	<p>USB Angled Extension Cable</p> 	<p>Hands Free Microphone</p> 

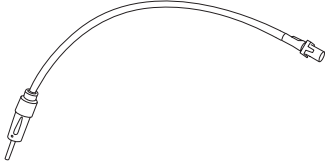
iDatalink Maestro Box Parts (ALP-MRR4/ALP-HRN-WRA4)

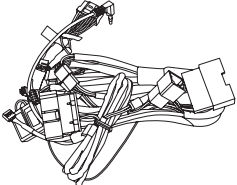
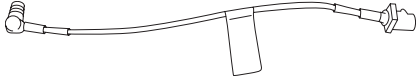
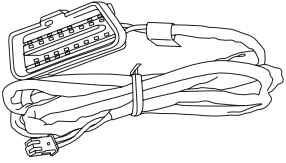
<p>Maestro Flashing Cable USB Micro To Full Size</p> 	<p>FM/AM Antenna Adapter</p> 	<p>iDatalink Maestro Module</p> 
<p>Main Harness</p> 	<p>SiriusXM Radio Antenna Adapter (only for vehicles with factory SiriusXM)</p> 	<p>OBDII Adapter Cable</p> 

Programming the iDataLink Maestro Module

1 INSTALL THE WEBLINK PLUG-IN

Go to:

idatalinkmaestro.com/plugin and follow the installation steps. The Maestro module must be programmed specifically for each vehicle and radio. Take care to enter the correct vehicle information, factory options, head unit model, and head unit serial number. The head units serial number is a 9 character alphanumeric value which is found on the head units label, underneath the bar code.

Review the System Requirements before installing.



If the plugin is already installed, the caution, “The plugin is already installed” appears. Please skip to step 2.

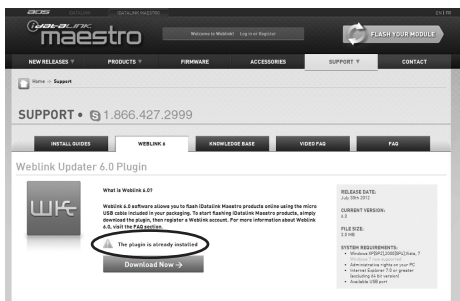

3 CONNECT YOUR MAESTRO MODULE

Use your Maestro module to connect to your PC.

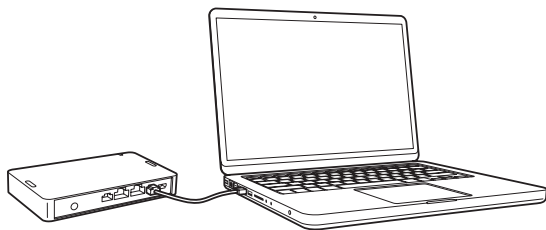

5 PROGRAM YOUR MODULE

Follow the programming steps for your vehicle.



2 REGISTER A WEBLINK ACCOUNT

Go to:

idatalinkmaestro.com/register and complete the registration process.

A confirmation email will be sent to you requiring validation.



For existing customers, click log in.



4 LOG INTO WEBLINK

Go to:

idatalinkmaestro.com/login.

Enter your username and password, then click OK.



6 Once Programming is complete “FLASHING COMPLETED!” will be displayed.

Proceed to the next page to complete installation.



NOTE: If serial number is invalid, Call ADS at 1-866-427-2999 with the serial number.

Factory Unit Disassembly Process (2007-2010 Only)

⚠ DISCONNECT THE BATTERY BEFORE CONTINUING. FAILURE TO DO SO WILL DISABLE MANY FEATURES.

1 Remove top by releasing 2 rear clips on the back of the top panel and then pull panel forward.

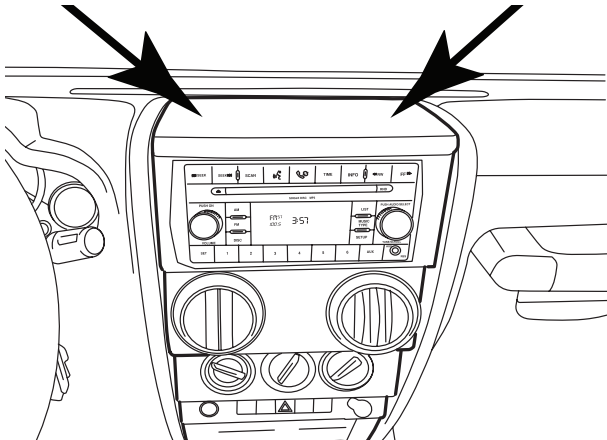

2 Release 2 clips on the top of the bottom panel. This will expose two 7mm screws. Remove those.

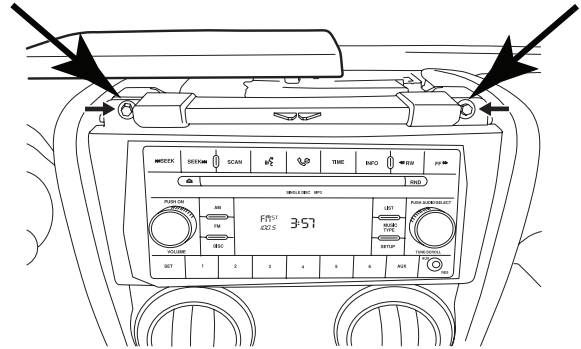

3 Release 2 clips on the top of the bottom panel. This will expose two 7mm screws. Remove using a 7mm socket with ratchet & extension.

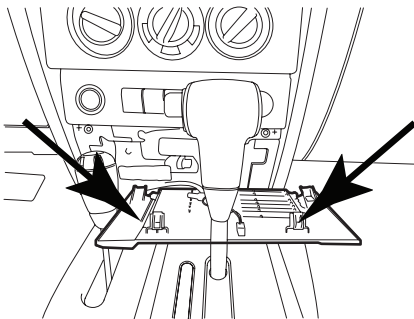

4 Use panel removal tool to remove dash panel by releasing 6 clips (3 per side)

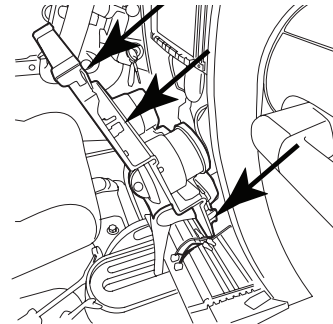

5 Extract (4) 7 mm screws and remove the factory radio.

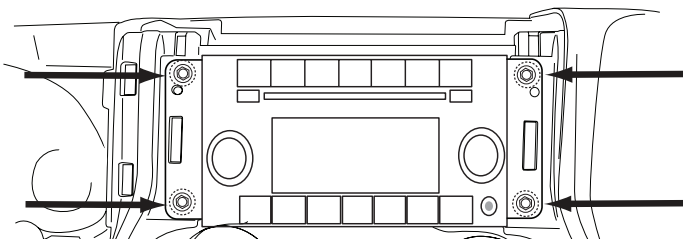

Factory Unit Disassembly Process (2011-2017 Only)

⚠ DISCONNECT THE BATTERY BEFORE CONTINUING. FAILURE TO DO SO WILL DISABLE MANY FEATURES.

1 Remove the rubber cover from the top center storage area and extract (1) 7mm screw.

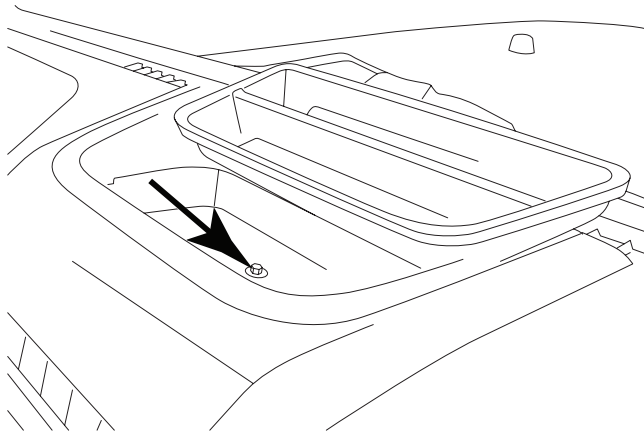

2 Remove the knee cover panel and extract (2) 7mm screws located to the right and left sides of the steering wheel column.

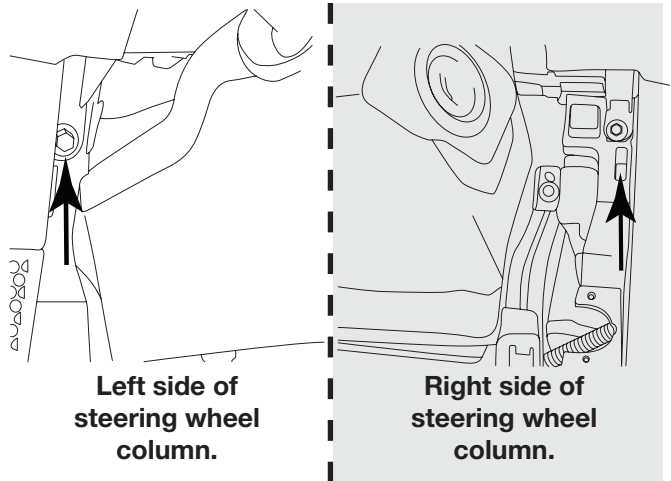

3 Remove the window switch pod using a panel removing tool and extract (1) 7mm screw.

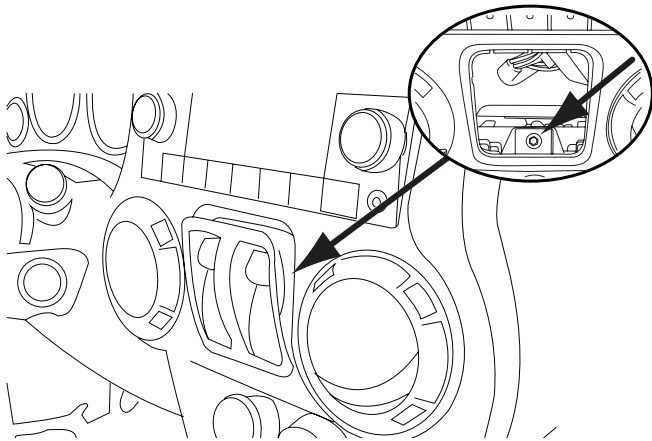

4 Remove the dash panel.

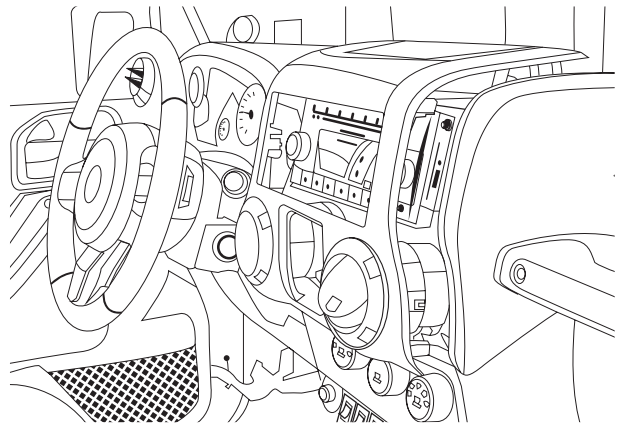

5 Extract (4) 7 mm screws and remove the factory radio.

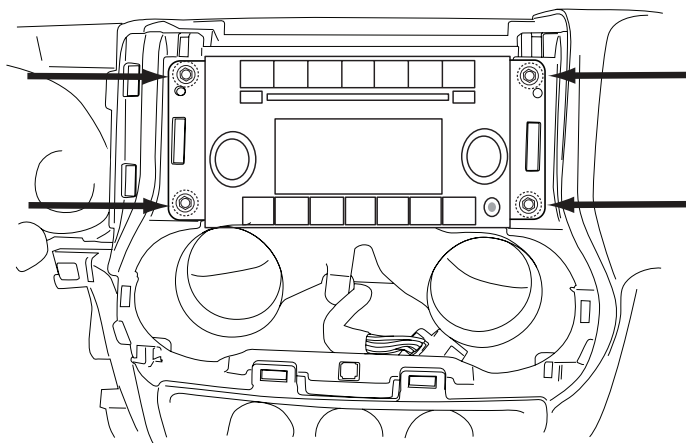

6 Use a cutting tool to trim the highlighted area shown below.

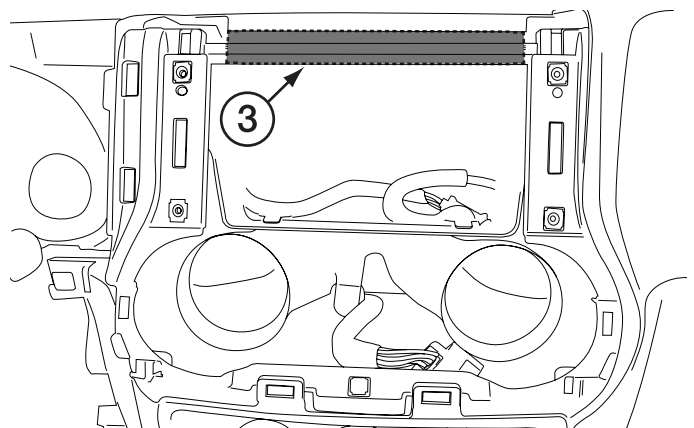

Installation Instructions

- 1 Plug the OBDII connector on to the OBDII port below the driver side dash and run the extension to the radio cavity.

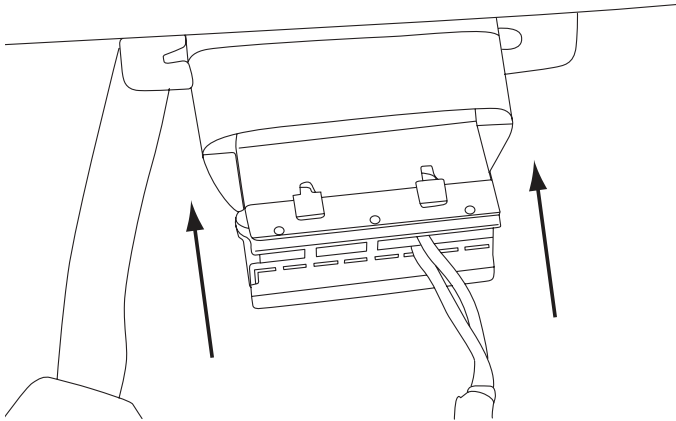

- 2 Attach the side brackets using the provided 8mm round head screws.

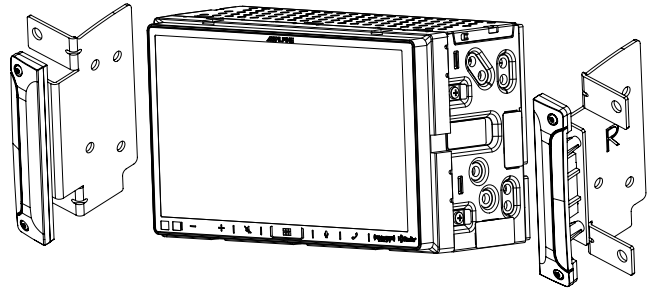

- 3 Mount the microphone as illustrated and run the cable to the radio cavity. You will need to use a T20 Torx to remove the visor. For optimal performance it should be mounted by the rear-view mirror as illustrated.

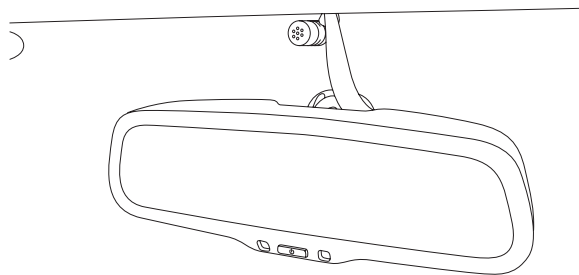

- 4 Run the USB extension cable to an area you want to plug in at (typically the glove box or center console areas), connect the main harness, antenna, and other adapters to the factory harnesses and secure them.

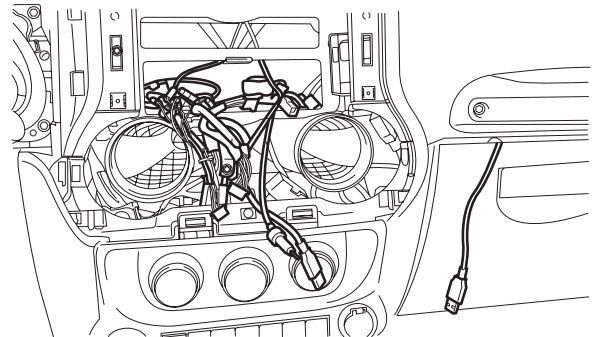

- 5 Mount the i407-WRA-JK head unit using the factory 7mm screws and return factory panels to their corresponding place

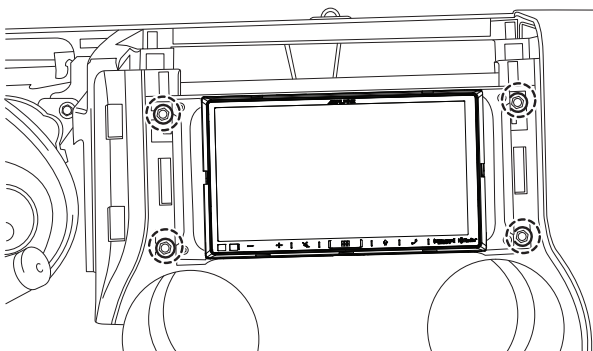

Disconnecting the Uconnect® (only for 2011-2017 vehicles with factory Uconnect®)

- 1 Remove the factory climate control panel. It is clipped on and can be removed with a panel removing tool. Extract the (2) 7mm bolts from Uconnect® module.

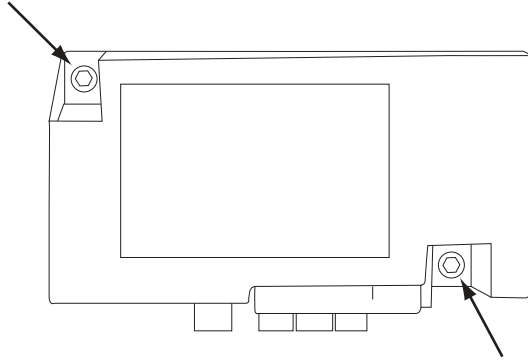

- 2 Disconnect the 24pin OEM connector.

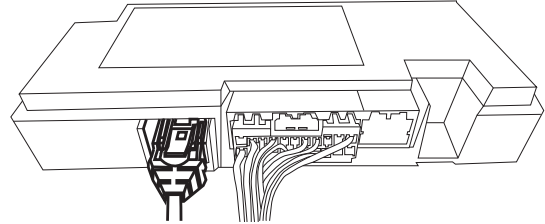

NOTE: Since the factory Uconnect® system is not going to be used you can unplug the 24 pin connector shown in step 2. If Uconnect® module is not disconnected the Uconnect® system will stay paired with previously paired phones. The user's phone may connect to both Bluetooth devices simultaneously resulting in unpredictable and potentially distracting behavior.

- 3 Secure the Uconnect® module to the original location using the 7mm bolts.

Connecting A SiriusXM Module (Sold Separately)

There is no way to integrate the factory SiriusXM tuner. Once the radio is removed, the factory SiriusXM is removed. As the title states, SiriusXM requires a tuner sold separately. This diagram shows how to integrate the antenna connection. For vehicles with factory SiriusXM connect the adapter to the factory SiriusXM antenna in the radio cavity. The factory SiriusXM antenna is located on the passenger side B-pillar. For vehicles without factory SiriusXM use the antenna that is included with the SXV300 SiriusXM Tuner.

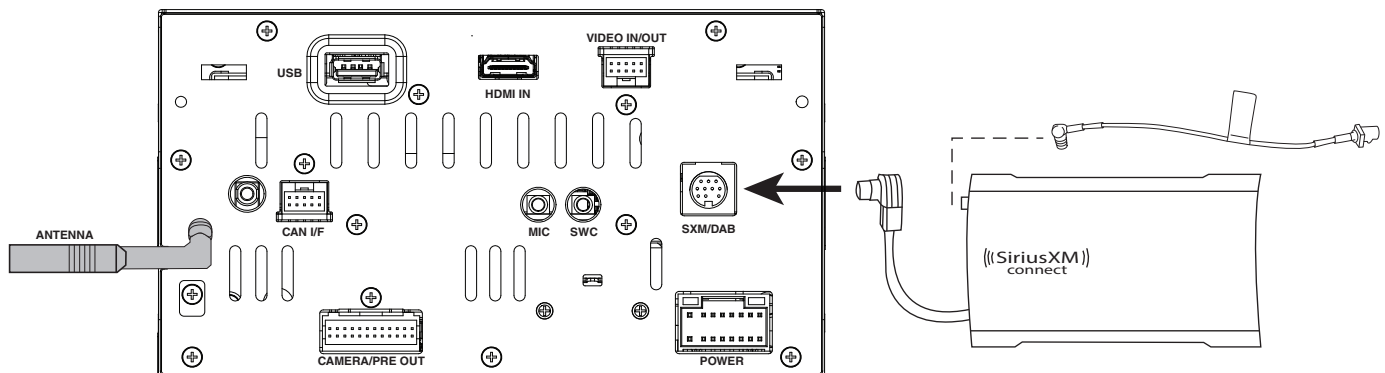

i407-WRA-JK Wiring Diagram

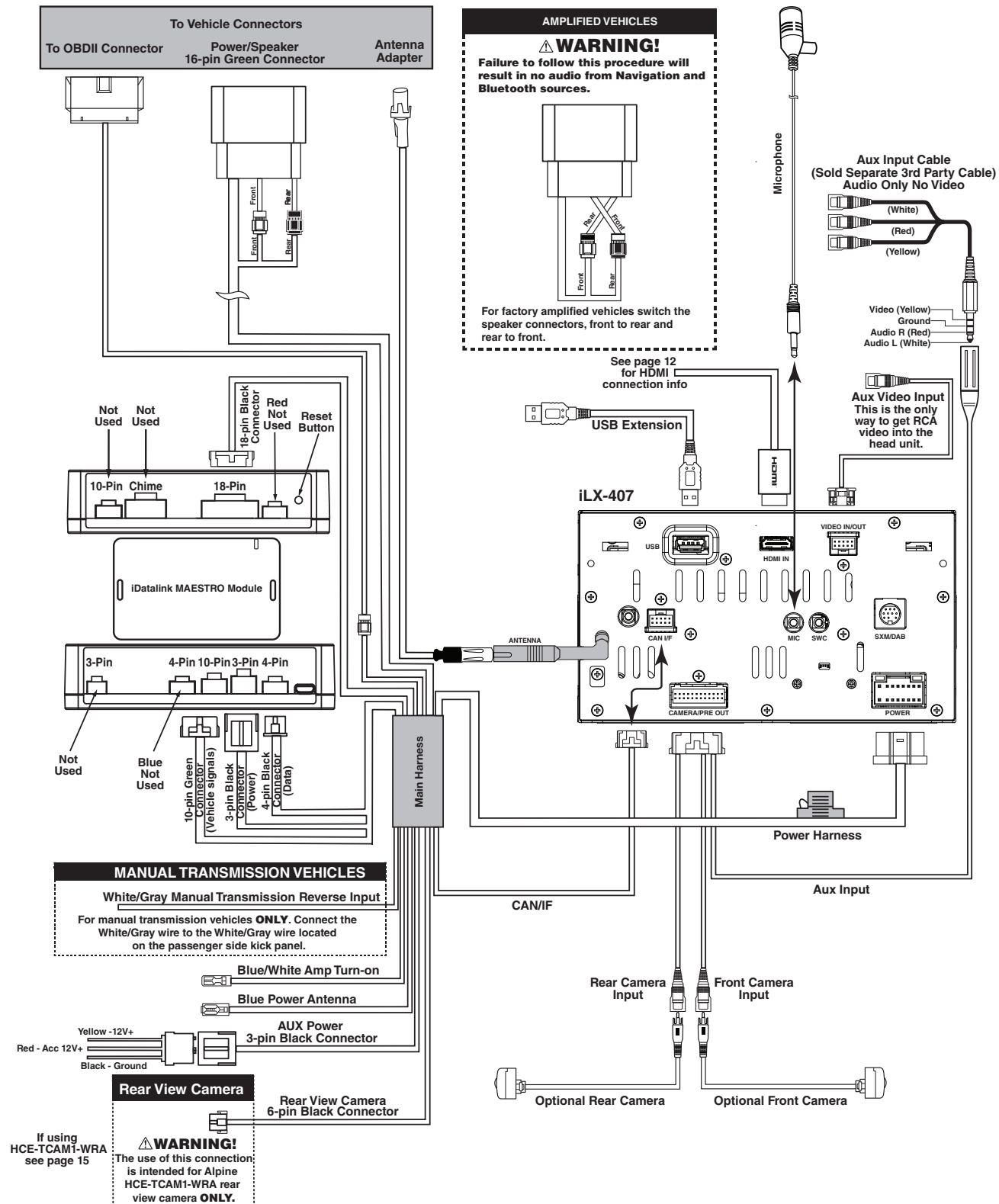

Component Locations

! IMPORTANT: These would be the typical locations used to install the separate components. The Maestro module and SiriusXM tuner (sold separately) would not have restrictions and could be moved based on the installers discretion.

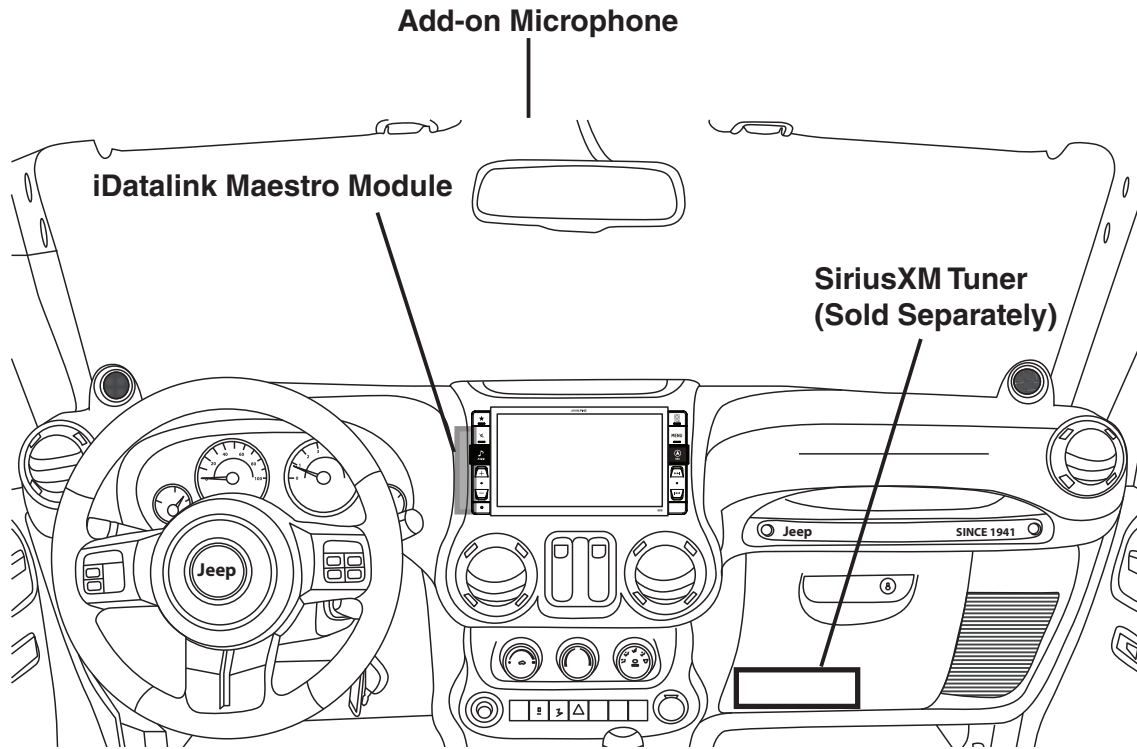

Connection Of An External Amplifier

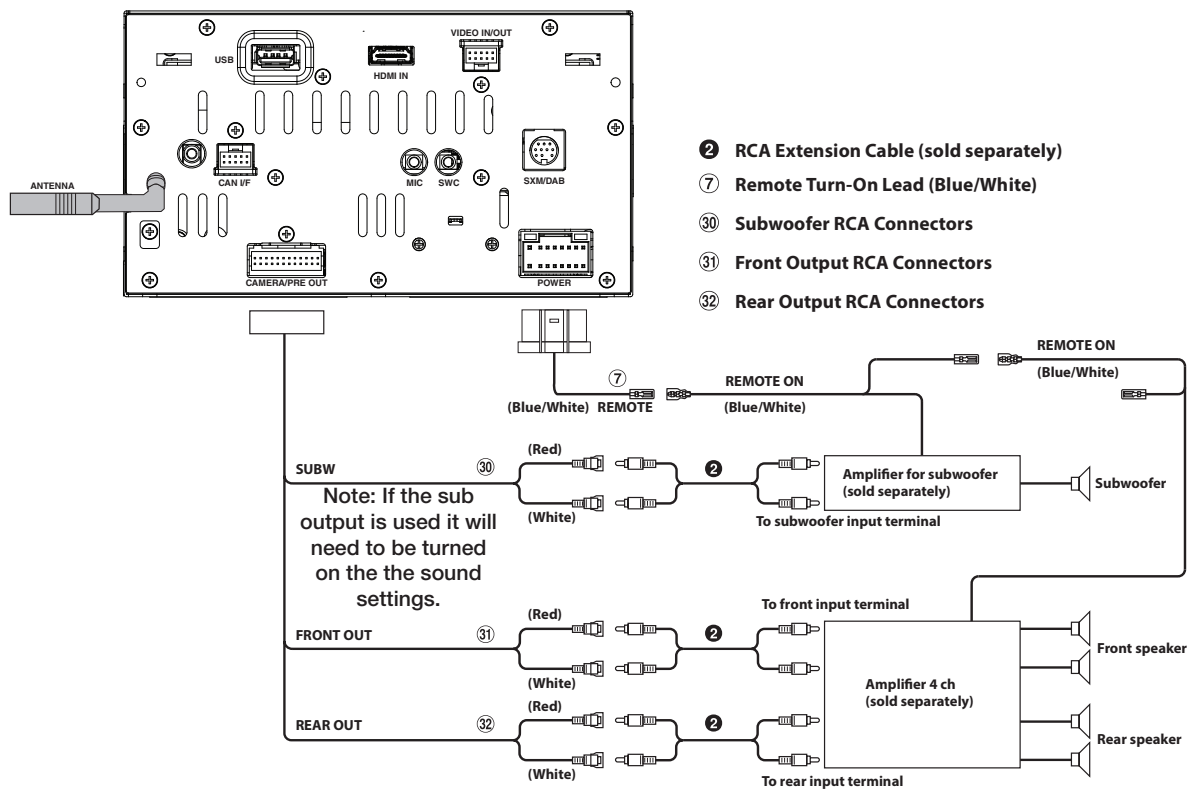

i407-WRA-JK HDMI Usage With An iPhone

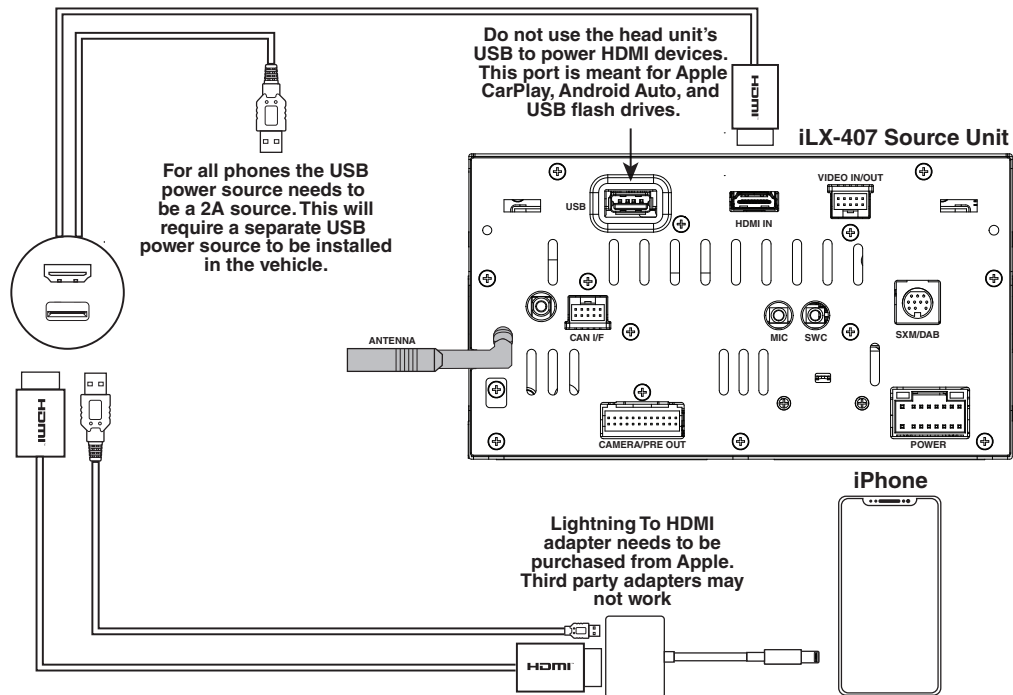

i407-WRA-JK HDMI Usage With An Android Phone

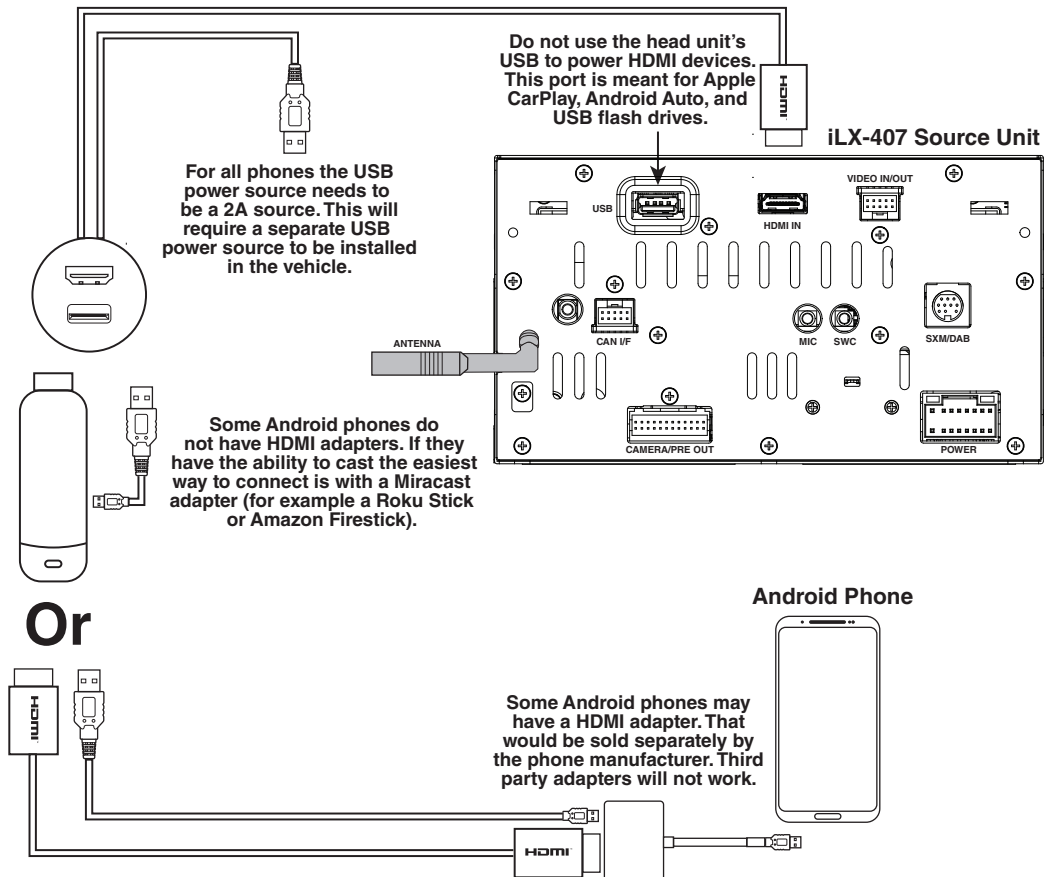

i407-WRA-JK Wire Descriptions

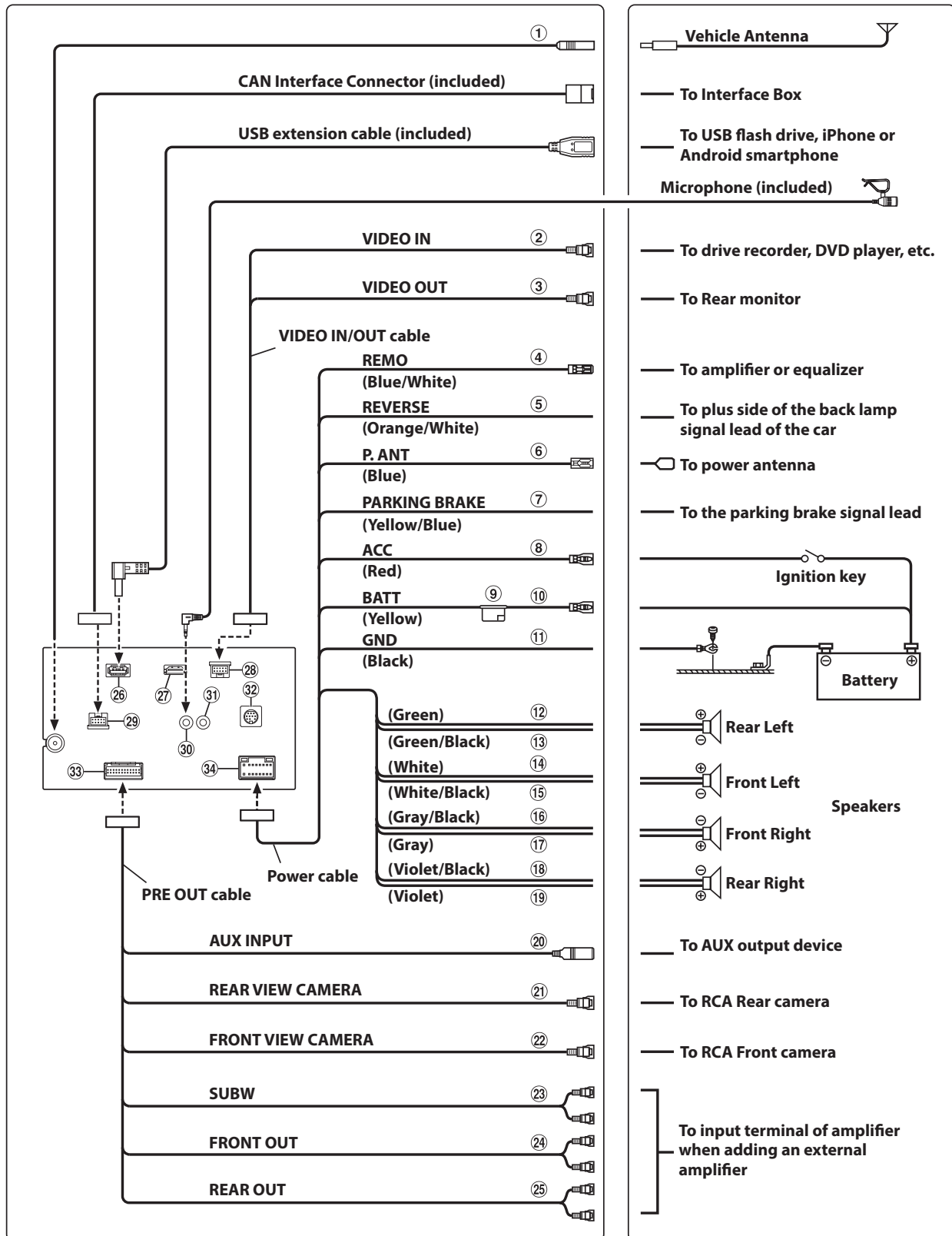

Wire Harness Pin Outs

Radio Main



Radio I/O

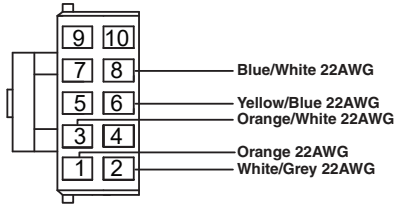

CAN I/F

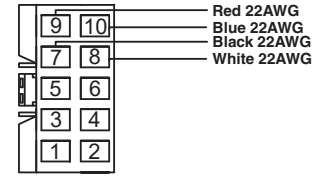

Data SWC

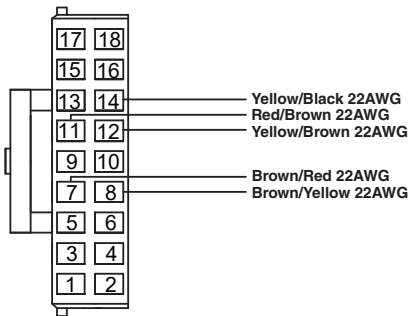

Rear Camera

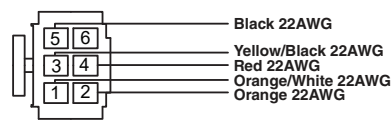

iDataLink



Maestro Power

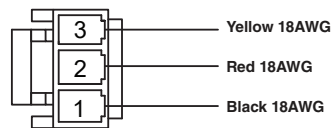

Aux Power

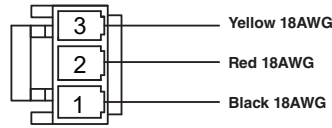

Aux Power Pigtail



Wrangler Harness

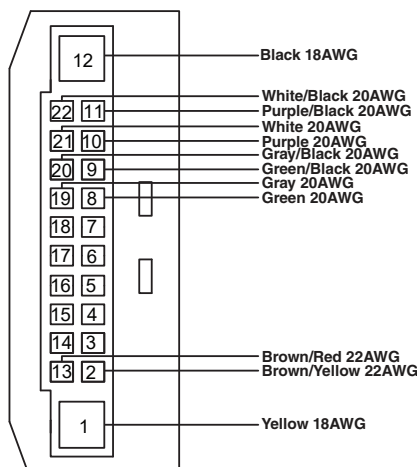

Speaker Harness

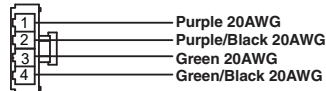

Speaker Harness



OBDII



Adding The KTA-450 (Sold Separately) (2011-2017 Only)

To make room for the KTA-450 the tabs on the OEM rear support bracket need to be bent outward about 1/2" as shown in the pictures below. This will help support the rear and amplifier. A protective tape or heat shrink needs to be used so the metal does not cause damage to the amplifier. The push nut from the OEM rear support bracket will also need to be removed.

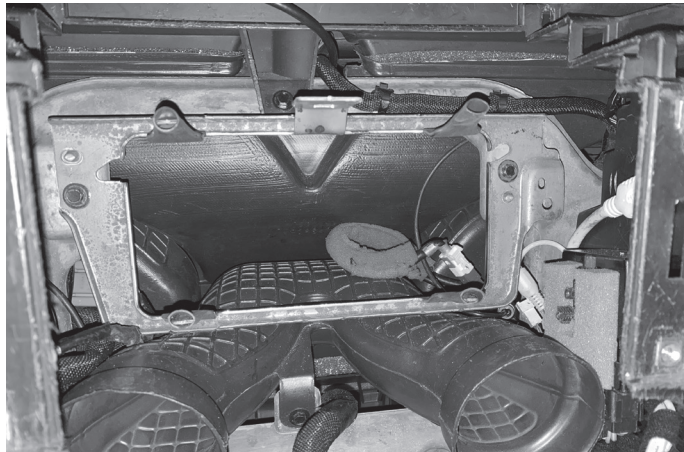
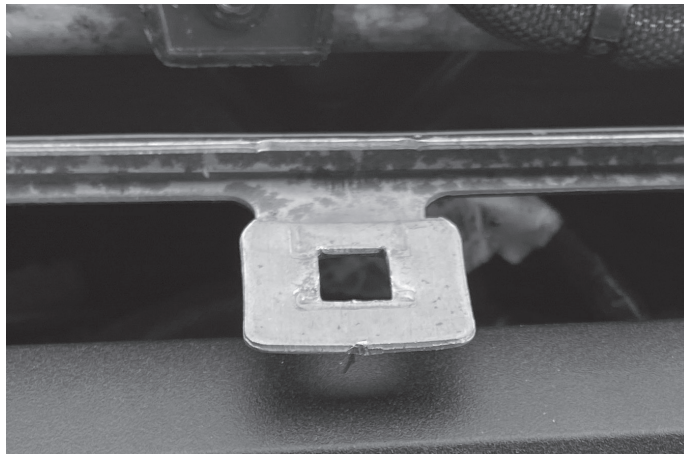

Set Up Guide

- 1 Turn the vehicle's Ignition switch to ACC.
- 2 Turn ON the i407-WRA-JK by pressing any key.
- 3 With the vehicle parked, engage the parking brake, release the parking brake and engage the parking brake again.
- 4 If a rear camera is present, turn it ON in the settings menu. (HOME/SETTINGS/CAMERA/REAR CAMERA/CAMERA SELECT/REAR/OK).
- 5 If a front camera is present, turn it ON in the settings menu. (HOME/SETTINGS/CAMERA/FRONT CAMERA/CAMERA SELECT/FRONT/OK).
- 6 If the AUX Input is being use be sure to turn it ON in the settings. (HOME/SETTINGS/GENERAL/AUX/AUX SELECT).
- 7 Vehicle information- Set the desired gauge information. (HOME/SETTINGS/GENERAL/IDATALINK).

Detailed descriptions of the settings can be found in the owners manual which can be downloaded from the support page of the website.

Troubleshooting Guide

Symptom		Possible Cause	Remedy
1	iPhone not working with HDMI.	Not using Apple HDMI to Lightning adapter.	Purchase the HDMI to Lightning adapter directly from Apple. Not all 3rd party adapters work the same.
		Didn't plug USB power into a 2A source.	Do not plug into the USB from the Alpine head unit. A third party USB adapter will need to be used that is 2A.
2	Android phone is not working with HDMI.	Using incorrect HDMI adapter.	If the phone has the feature to use an HDMI adapter it must be the one purchased from the manufacturer of the phone, not a third party adapter.
		Miracast adapter isn't plugged into a 2A source.	Do not plug into the USB from the Alpine head unit. A third party USB adapter will need to be used that is 2A.
		Miracast adapter has resolution settings that are too high.	Plug the adapter into another monitor (for example a television in the home) and reduce the resolution settings.
3	iDatalink website says serial number is invalid.	Incorrect serial number is being used.	In the i407-WRA settings confirm the serial number. HOME/SETTINGS/GENERAL/ABOUT/VERSION INFORMATION.
		Serial number may not be in iDatalink database.	Call ADS at 1-866-427-2999 and verify.
4	No output from RCA's	Maestro module is flashed for amplified system.	Re-flash module for non-amplified system.
5	Navigation voices and/or Bluetooth audio can't be heard.	The vehicle has an OEM amplifier and the warning on page 11 was not followed.	Swap the front and rear speaker connectors as shown on page 11.
6	Steering wheel controls aren't working. Vehicle data isn't displaying.	Maestro module was not flashed.	Flash the maestro module as shown on page 5.
		Connection was not made properly.	Every harness needs to be plugged into it's proper place. Follow page 11 and ensure every connection is going exactly where it needs to be.

Troubleshooting Guide Continued

Symptom		Possible Cause	Remedy
6	Headunit will not turn on.	One of the power wires does not have proper voltage	Test the power wires with a digital multimeter and trace from there.
		4 pin Maestro data cable is disconnected or damaged.	Check for proper connection or disconnected pins.
		OBD2 cable is not plugged in.	Connect OBD2 connector to the OBD2 port.
		Main harness is not connected.	Check for proper connection or disconnected pins.
7	Cannot enter SETTINGS MENU.	Vehicle is in motion or parking brake is not engaged.	With vehicle in (P)PARK engage the parking brake. Release the parking brake and engage the parking brake a second time, as shown in the Setup Guide on page 16.
8	Sound mutes when vehicle is shifted into reverse.	Mute While Backing Up is turned on in the rear camera setup.	Change Mute While Backing Up to off.
9	Only the front speakers are on for SXM Radio.	SXM Tuner has not been activated.	Activate SXM Tuner.
10	iPhone or Android phone is not recognized when connected to the USB cable, causing CarPlay or Android Auto to not function.	Loose or disconnected USB cable.	Check the USB connection behind the headunit.
		Non-compatible cable.	Use the cable supplied with the iPhone or Android phone and only plug into the extension provided with the head unit. Third party adapters like flush mount, OEM integration, and/or long extensions may not work. Only use USB extension that came with the head unit.
		Dirty charging port on phone.	Clean charging port.
11	Rear camera not automatically coming on when vehicle is in reverse.	The rear camera was not turned on in the setup menu.	Refer to Step 4 of the Set Up Guide on page 16.
		Reverse wire not properly installed.	If the vehicle is a manual transmission the reverse wire needs to be connected to the correct wire in the passenger kick panel as shown on page 11. The wire will need to be tested and verified with a digital multimeter.
12	Rear camera just shows blank image with guide cones.	The rear camera is not outputting an image.	The rear camera is either not powered on properly or the video connection was not made properly.
13	Front camera image is reversed.	A front camera was not used.	A rear camera can not be used for the front of the vehicle. It will not display the image correctly and it will be reversed.
14	Installed an amplifier and it only gets sound on FM.	The power antenna wire was used instead of the remote wire.	The remote wire is what needs to be connected to the remote turn on lead of the amplifier.
15	Can't be heard when making phone calls.	The microphone is not plugged into the correct port.	The microphone needs to be plugged into the port labeled "MIC". If it gets plugged into the SWC port it will not function properly. Page 11 shows the correct port to plug into.